

Innovative Technologies | www.ermaksan.com.tr | Plasma Series



EPL Plasma

Plasma Cutting Machines



CNC PLASMA CUTTING MACHINE

Your partner for presentation of the needs

EPL Plasma 3 Axes Series.

It offers the optimum solution to all your needs with its advanced accurate cutting quality, production line and automation.

Special plasma software and CNC controller enables the operator to use the machine with ease.

R&D engineering calculations; Knowledge gained from research has been integrated into the development of the main frame/body and moving bridge of the EPL Plasma Cutting Machine giving a higher cutting quality.

EPL Plasma Series is the best and most economical machine when looking at consumable part consumption.

Ermaksan offers consumables, parts and Hypertherm materials at very competitive prices.

ArcGlide™ THC
Torch height control.

Double motor technology
The cutting heads on the bridge which use the X1 X2 motors move separately. Capable to cut Parallel and mirror cutting. (Optional)

Oxygen cutting station
(Optional)

Suction Control Unit
It provides a healthy working place by filtering smoke that occurs during the cutting process. (Optional)

Hypertherm® HPR400 XD® Plasma Source
High cutting quality, high efficiency and high performance. (Given as standard HPR130XD®)

EDGE® PRO Control Panel
15" touch screen colored controller.

Linear Guideways
Guideways with high accuracy no backlash.

Rack and Pinion
Accurate and quiet racks.

CNC PLASMA CUTTING MACHINE

Your partner for presentation of the needs

The best choice for plasma with its high productivity and accurate cutting quality.



Advantages+

- High cutting technology.
- Minimum operating cost
- Long working life
- EDGE® Pro Controller
- HyDefinition® technology
- PowerPierce™ technology
- LongLife™ technology
- HPRXD® plasma source.
- TurboNest® nesting software.



CNC PLASMA CUTTING MACHINE

Your partner for presentation of the needs

Standard Equipment

- **Hypertherm EDGE® Pro CNC**
 - * 15" LCD industrial type touch screen
 - * Hypertherm operator panel
 - * Safety module input and output
 - * Hypernet communication system
 - * Remote connection interface
 - * Phoenix interface
 - * Metric and inch gauges.
- **HyPerformance® HPR130XD® plasma source**
 - * Hypertherm manual gas console
 - * Plasma marking
- **Arc Glide™ THC automatic height control system**
 - * Hypernet communication system
 - * Safety input-output interface module
 - * Nozzle sensor
 - * Collision sensor
 - * 220 mm standard stroke
 - * Laser Pointer
- **TurboNest® Cad/Cam software**
- **3 Axis (X,Y,Z)**
 - * 3 pieces Mitsubishi AC servo motor and driver
 - * 3 pieces planet type Neugart gear box
 - * High accuracy linear rails
 - * High accuracy an silent Atlanta Helis rack and pinion
 - * X,Y, Z Axis Icus brand silent cable tray
- **Cutting table with pneumatic system**
- **Moving control panel system**
- **2 Emergency buttons**
- **6 Mechanical stops**

TurboNest® Nesting Software

Standard features highlights

- **Part creation and development**
 - Integrated 2D CAD program to create and edit CAD files
 - Variable Shape Parts feature to develop common parts from templates.
- **CAD/CAM import and conversion**
 - Import CAD and CNC files (many industry-standard file formats Automatic CAD file correction and error notification.
 - Automatic spline / ellipse smoothing and reduction.
 - Separate multiple parts from a single CAD file.
 - Automatic mapping of CAD layers to processes (cut, mark, etc.).
- **Interactive manual nesting**
 - Group parts into clusters for nesting.
 - Drag, drop and bump parts on the nest .
 - Duplicate, move, scale, mirror, rotate, or array parts.
 - Prohibit / permit nesting inside of a part.
 - Multi-sheet and multi-head nesting.
 - Part interference detection.
 - Edit lead-in / out position and properties within the nest.
 - Grain constraint and edge pierce technology.
 - Material database (with grade and gauge).
 - Manual and automatic plate cropping.
 - Safe zones for plate clamping applications.
 - Automatic and manual nest sequencing.
 - Control cut direction and cut sequencing on part-by-part basis.
 - Animated cutting sequence simulation.
- **Built-in process parameters**
 - Material type, thickness, grade and class-based process parameters.
 - Material type and thickness based lead-in / out parameters.
 - Automatic and interactive separations for part, plate, and pierce spacing.
- **Reporting**
 - Management and shop reports.
 - Export reports directly to PDF, Excel spreadsheet (*.xls), CSV (*.csv), or Web page (*.html).
- **Costing**
 - User-defined machine and labor production costing.
 - Automatic calculation of part production costs and part/nest utilization.

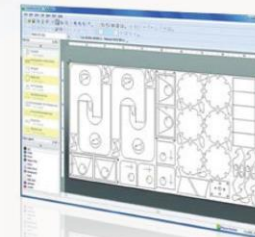

Advantage+

- Better productivity
- Improved part quality
- Increased cost savings
- More efficient use
- Fewer errors

CNC PLASMA CUTTING MACHINE

Your partner for presentation of the needs

EDGE® Pro Controller



Designed to be flexible and easy to use, the EDGE Pro delivers reliable performance for improved profitability and application performance such as True Hole technology. Using Phoenix software, this CNC improves cut quality and productivity by delivering our expertise directly to your factory, giving the best results with every operator.

Advantages+

Easy

- Using the CutPro™ Wizard new operators can be ready to cut production parts in less than 5 minutes.
- Built-in two-station operator's console, with tactile joystick, speedpot, and torch position control for easy operation.
- Network and USB access for part program loading and software updates.
- Built-in help and cutting optimization tips for improving table performance and process outcomes on demand.

Reliable

- Durable glass touchscreen utilizing surface acoustic wave technology.
- Air cooling to reduce stress on electronic components without dust ingress.
- Designed and stress tested to ensure consistent operation in the harsh plasma cutting environment.
- Intuitive hardware service kit helps rapidly isolate system errors.

Performance

- Critical plasma, THC and table parameters can be controlled in the part program using Part Program Support (PPS) for repeatable cut quality.
- Watch Windows™ enable on-screen real-time monitoring of key process performance parameters while cutting.
- Custom cut charts can be created and controlled in the part program or made available to the CutPro Wizard.
- Support for fast transitions from marking to cutting.

Reliable, user friendly, high efficiency and applicability...

Ease of use: **Phoenix software**

- Built-in cut charts for automatically setting process parameters for mild steel, stainless, and aluminum to enable consistently optimized cutting performance. Wizards and diagnostic support tools that enable easy setup, use and rapid troubleshooting.



As easy as 1, 2, 3, cut! : **CutPro™ Wizard**

- In field trials, new operators began cutting high-quality parts in less than 5 minutes without training, drastically reducing the "hire to cut" time.



1. Step: Select CNC program.



2. Step: Select process.



3. Step: Align part/plate.



Cut.

Remote Help

- Remote Help is an internet based tool that allows the manufacturer to be virtually in your factory within minutes. CNC, plasma system and cutting table diagnosis and repair can often be accomplished without an on-site visit. This means that machines can be up and running quickly and without costly travel and wait time.

Standard Features

Operating system	Windows® XPe
Hard drive	SATA drive
Display	15" glass touchscreen (surface acoustic wave technology)
Memory	≥1GB
USB interface	Two USB 2.0 ports
Dimensions	435 mm (17.125") W; 463 mm (18.22") H; 316 mm (12.43") D
Temperature range	-10° C to 40° C ambient (14° F to 104° F ambient)
Warranty	Two-year warranty standard
Regulatory compliance	CE, CSA
Operator's console	Two-station Opcon standard
Operating voltage and frequency	100 – 240V, 50/60 Hz
Software utilities	Part Program Support (PPS), Remote Help, networking, Autogas support, DXF import, and simple shape nesting

CNC PLASMA CUTTING MACHINE

Your partner for presentation of the needs

ArcGlide™ THC

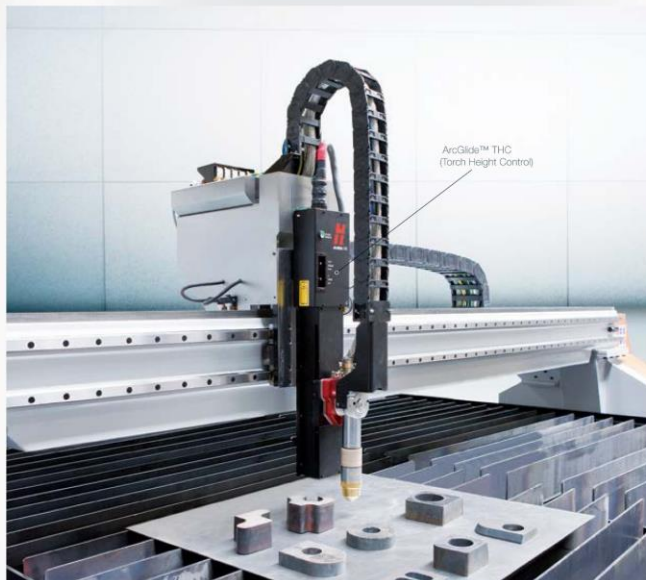

Advantages+

- Superior cutting quality and ideal consumables life with arc voltage sampling and control.
- Up to 80 % increases in parts per hour production by minimizing cut to cut cycle time.
- Ultimately strong mechanics under 2 years warranty.
- Easy to use human machine interface for under one minute fast job adjustment.
- Performance advantages are achievable with minimal operator input, eliminating the need for extensive training and allowing you to get the best performance across any shift with any operator at any plant.

Increase parts per hour

Up to 100% improvement in parts cut per hour by rapid ignition and movement optimization coded on software.



Example part 203 mm flange

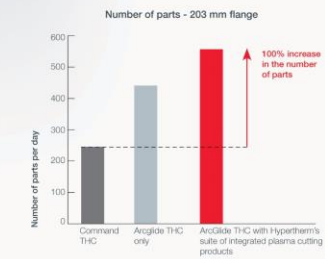
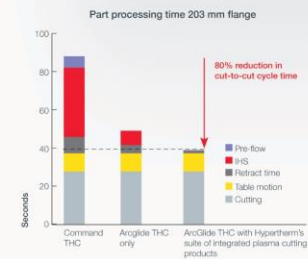

Decrease cost per part

ArcGlide THC continuously samples arc voltage and automatically adjusts arc voltage for proper torch height over the life of the consumables without requiring operator input.

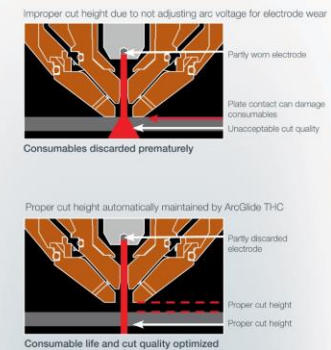
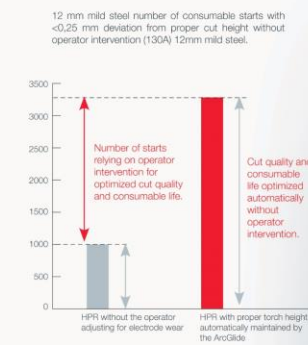

CNC PLASMA CUTTING MACHINE

Your partner for presentation of the needs

Hypertherm HPRXD® Plasma Sources

HyPerformance® offers quality and sensitive cuts along with high productivity. HPR XD® plasma sources offer better general performance, productivity and profitability with its unique combination of superior technologies.

System Technology (Shown on HPR130XD®)

Power source and chiller

- The addition of pump motor drives, fans, and eliminates the effect of frequency on the cooling water flow.



Power Supply

- Self calibrating current control for better current adjustment.
- High power element/ productivity.
- Low fluctuation on exit current for lower arc voltage lapse and more stable plasma arc.
- Serial communication port on CNC for system surveillance.
- CAN serial communication between main modules for system stability.
- Long distance surveillance feature if CNC is connected to network.

Manual Gas Console

- Provides HyDefinition cutting quality with LongLife Technology.
- Compensates for changes in the incoming gas pressure.
- Continuously measures and adjusts the flow of gas.

Torch

- Quick disconnect torch reduces installation time.

HPR130XD® Operating data

Mild steel cut capacity	
Dross free	16 mm
Production pierce	32 mm
Maximum cutting capacity	38 mm
Stainless steel cut capacity	
Production pierce	20 mm
Maximum cutting capacity	25 mm
Aluminium cut capacity	
Production pierce	20 mm
Maximum cutting capacity	25 mm

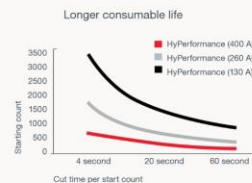
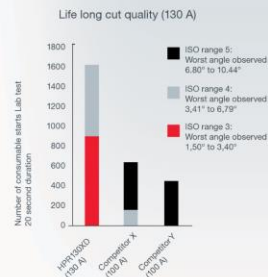

Advantages+

Increased parts per hour

- HyPerformance Plasma systems provide faster cut speeds to produce more parts per hour.
- Hypertherm's patented PowerPierce™ technology makes it possible to cut thicker than ever before and replace slowercutting technologies such as oxyfuel.
- HyPerformance Plasma's superior quality and consistency maximize the number of parts produced per hour by minimizing time-consuming secondary operations.

Do more with less power

- HyPerformance Plasma enables extremely high cutting speeds per amp with less cutting current than other plasma solutions on the market.

Longer consumable life

- LongLife® and PowerPierce™ technologies significantly increase consumable life and reduce your cost per part.
- Hypertherm consumables are manufactured with the highest quality standards to ensure consistently longer life.

Do more with less power.

- Patented consumable designs enable industry-leading cutting speeds and robust production piercing using lower amperage levels.
- HyPerformance Plasma enables extremely high cutting speeds per amp with less cutting current than other plasma solutions on the market.
- Hypertherm's power supplies are designed to be extremely efficient in their use of electricity, enabling lower electrical expense and a reduced impact on the environment.

HPRXD plasma selections working data

	HPR260XD (30-260 amp)	HPR400XD (30-400 amp)	HPR800XD (30-800 amp)
Mild steel cutting capacity			
Dross free	32 mm	38 mm	38 mm
Production pierce	38 mm	50 mm	50 mm
Maximum cutting capacity	64 mm	80 mm	80 mm
Stainless steel cutting capacity			
Production pierce	32 mm	45 mm	75 mm
Maximum cutting capacity	50 mm	80 mm	160 mm
Aluminium cutting capacity			
Production pierce	32 mm	45 mm	75 mm
Maximum cutting capacity	50 mm	80 mm	160 mm

Automatic gas console option

- Allows full control of all plasma system settings from the CNC, simplifying operator training requirements.
- Automatically changes processes on the fly to enable rapid switching between cutting and marking.
- Automatically adjusts for variations in incoming gas pressure to produce the most consistent cutting performance.



CNC PLASMA CUTTING MACHINE

Your partner for presentation of the needs

Ermaksan EPL series cutting machine provide more consistent cut quality and more powerful precision cutting which is Hypertherm's patented technologies.

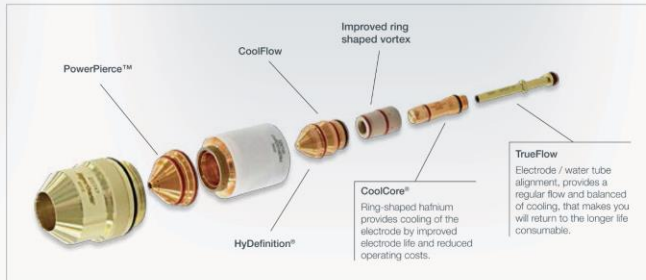

HyDefinition® Technology

- Mouthed nozzle technology aligns and focuses the plasma arc.
- HyDefinition technology enables powerful precision cutting for superior quality and consistency.

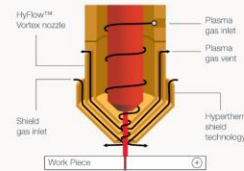

LongLife® Technology

- Hypertherm's patented LongLife® technology increase and decrease gas flow and gradually to reduce electrode and nozzle erosion in extremely controlled manner.
- By reducing erosion of electrode and nozzle with LongLife®, longer period with more consistent quality of a cut while offers a significant reduction in operating cost.

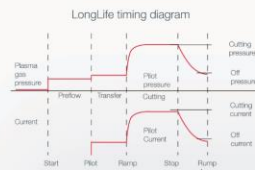

PowerPierce™ Technology

- Patented PowerPierce liquid cooled shield repels molten metal during piercing
- For maximum pierce capability of up to 50 mm mild steel and 75 mm stainless steel.
- Patented consumable designs deliver speed and thickness capabilities expected of higher amp systems

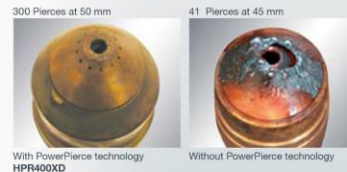

For a better quality performance at any point

Ermaksan's high-quality and high-precision cutting machine, never compromising on quality, manufactured with the customer in mind, right down to the smallest detail.



Cable tray

Comply with CE standards. Due to high quality plastic material used in the cable tray it encompasses quality, durability, resistance to abrasion, durability to heavy loads and resistance to breaks and protects the cable ducts.



Linear guideways and carriages

High-precision linear guideways and carriages are used in accordance with CE standards. So it provides high precision cutting results .

Germany origin Atlanta helical rack used in accordance with CE standards and provides high precision cutting results, increased sensitivity range and cut quality. Also the sound caused by friction is minimized. Thread quality is 9e27.



Cutting table and pneumatic suction system

PLC software follows the cutting head movements and individual pneumatic flaps at related cutting sector open; proves high efficiency suction of waste gas, dust and fume from working environment.



Servo motor and planet type gear box

Double driven synchronous brushless 3 pieces AC servo motors used on X and Y axes. With high-precision servo motor reaction times, drive and gear, high acceleration is provided.

CNC PLASMA CUTTING MACHINE

Your partner for presentation of the needs

EPL Plasma 3 Axes Series Technical Data

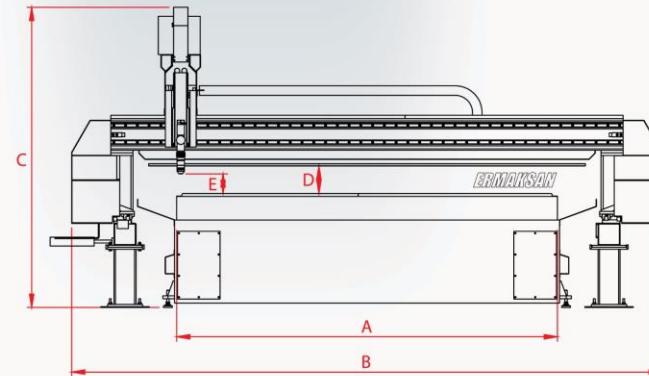

PLASMA SERIES			EPL 1530 Compact	EPL 2040 Compact	EPL 2060	EPL 20120	EPL 2560	EPL 25120	EPL 3060	EPL 30120	EPL 4060	EPL 40120
CUTTING WIDTH	A	mm	1500	2000	2000	2000	2500	2500	3000	3000	4000	4000
TOTAL WIDTH	B	mm	2500	3700	3700	3700	4200	4200	4700	4700	5700	5700
TOTAL HEIGHT	C	mm	2280	2280	2280	2280	2280	2280	2280	2280	2280	2280
INTER GAP	D	mm	200	200	200	200	200	200	200	200	200	200
TORCH DISTANCE	E	mm	100	100	100	100	100	100	100	100	100	100
CUTTING LENGTH		mm	3000	4000	6000	12000	6000	12000	6000	12000	6000	12000
TABLE HEIGHT		mm	900	900	750	750	750	750	750	750	750	750
SPEED		m/min	35	35	35	35	35	35	35	35	35	35
MACHINE AXIS	-		X, Y, Z	X, Y, Z	X, Y, Z	X, Y, Z	X, Y, Z	X, Y, Z	X, Y, Z	X, Y, Z	X, Y, Z	X, Y, Z
POSITIONING ACCURACY		mm	± 0,1 DIN 28206	± 0,1 DIN 28206	± 0,1 DIN 28206	± 0,1 DIN 28206	± 0,1 DIN 28206	± 0,1 DIN 28206	± 0,1 DIN 28206	± 0,1 DIN 28206	± 0,1 DIN 28206	± 0,1 DIN 28206
REPETITION ACCURACY		mm	± 0,05 DIN 28206	± 0,05 DIN 28206	± 0,05 DIN 28206	± 0,05 DIN 28206	± 0,05 DIN 28206	± 0,05 DIN 28206	± 0,05 DIN 28206	± 0,05 DIN 28206	± 0,05 DIN 28206	± 0,05 DIN 28206
PLASMA CUTTING UNIT			Hypertherm 130XD	Hypertherm 130XD	Hypertherm 130XD	Hypertherm 130XD	Hypertherm 130XD	Hypertherm 130XD	Hypertherm 130XD	Hypertherm 130XD	Hypertherm 130XD	Hypertherm 130XD
TORCH HEIGHT CONTROL			Hypertherm ArcGlide	Hypertherm ArcGlide	Hypertherm ArcGlide	Hypertherm ArcGlide	Hypertherm ArcGlide	Hypertherm ArcGlide	Hypertherm ArcGlide	Hypertherm ArcGlide	Hypertherm ArcGlide	Hypertherm ArcGlide
CUTTING CAPACITY		mm	1 - 38	1 - 38	1 - 38	1 - 38	1 - 38	1 - 38	1 - 38	1 - 38	1 - 38	1 - 38
ENERGY			400V, 50Hz, 6 bar air	400V, 50Hz, 6 bar air	400V, 50Hz, 6 bar air	400V, 50Hz, 6 bar air	400V, 50Hz, 6 bar air	400V, 50Hz, 6 bar air	400V, 50Hz, 6 bar air	400V, 50Hz, 6 bar air	400V, 50Hz, 6 bar air	400V, 50Hz, 6 bar air
WEIGHT		kg	3750	4750	6750	12000	7500	14000	8250	15000	9750	18000

CNC PLASMA CUTTING MACHINE

Your partner for presentation of the needs

Optional Equipment

- **Hypertherm Hydefinition Plasma Options**
 - * HPR260XD, HPR400XD, HPR800XD
 - * Hypertherm automatic gas console
- **Oxy cutting station**
 - * Messer-tanaka oxygen torch
 - * Ermaksan automatic ignition system
 - * IHT Automation capacitive distance and height control
- **Manual angle cutting apparatus for oxygen and plasma**
- **350mm and 500mm adjustable stroke for oxygen and plasma**
- **True Hole™ Technology**
 - * EDGE® Pro CNC Controller
 - * ArcGlide™ torch height control
 - * Hypertherm HPR XD® series
 - * Hypertherm automatic gas console
 - * ProNest® Cad/Cam software
 - * 3 piece Beckhoff AC Servo Motor and driver
 - * 3 piece planet type brushless harmonic drive gearbox
- **Pipe cutting technology**
 - * Linatrol Infinity one controller
 - * IHT M4000PCS 350mm stroke torch height control
 - * Lantek Flex 3D + Lantek Expert II Cad/Cam software
 - * Chuck and centering mechanism
- **5 axis plasma cutting technology**
 - * Esa Kvara cnc controller
 - * Automatic gas console
 - * Lantek Expert II software
 - * Angle cutting head
- **ProNest® Cad/Cam software**
- **Lantek Expert II Cad/Cam software**
- **Lantek Flex 3D Cad/Cam software**
- **Lantek Duct Cad/Cam software**
- **Linatrol Infinity CNC**
 - * Operator panel (1-8 station)
 - * 19" LCD
 - * Linatrol cut software
- **Plasma filter unit**
 - * ER4000 = 4000m³/h flow
 - * ER6000 = 6000m³/h flow
 - * ER10000 = 10000m³/h flow
- **Sick light barrier**
- **Online bypass features 3kva inform saver DSP UPS**
- **Air dryer**
 - * 600 lt./min flow 240V AC 50-60Hz
 - * 0.5, 0.05, 0.001 Micron Particle Removal Filter
- **Optional colours**
- **According to the working conditions cooling fan or heater can be add to the electrical panel**
- **Optional electrical voltage**
- **Conformity of European Union CE**

ProNest® Nesting Software

Standard Specifications

- **Part creation and development**
 - Integrated 2D CAD program to create and edit CAD files
 - Variable Shape Parts feature to develop common parts from templates
- **CAD/CAM import and conversion**
 - Import CAD and CNC files (many industry-standard file formats)
 - Import Bill of Materials properties from CAD files
 - Automatic CAD file correction and error notification
 - Automatic spline / ellipse smoothing and reduction
 - Separate multiple parts from a single CAD file
 - Automatic mapping of CAD layers to processes (cut, mark, etc.)
- **Interactive manual nesting**
 - Group parts into clusters for nesting
 - Drag, drop and bump parts on the nest
 - Duplicate, move, scale, mirror, rotate, or array parts
 - Prohibit / permit nesting inside of a part
 - Multi-sheet and multi-head nesting
 - Part interference detection
 - Edit lead-in / out position and properties within the nest
 - Automatically update nest with part revisions
 - Grain constraint, automatic tabbing / micro-joints, edge pierce technology
 - Material database (with grade and gauge), plate list and part library
 - Manual and automatic plate cropping
 - Safe zones for plate clamping applications
 - Automatic and manual nest sequencing
 - Control cut direction and cut sequencing on part-by-part basis
 - Animated cutting sequence simulation Built-in process parameters
- **Built-in process parameters**
 - Material type, thickness, grade and class-based process parameters
 - Material type and thickness based lead-in/out parameters
 - Automatic and interactive separations for part, plate, and pierce spacing
- **Reporting**
 - Customizable management and shop reports
 - Export reports directly to PDF, Excel spreadsheet (*.xls), or (*.csv)
- **Costing**
 - Detailed user-defined machine and labor production costing
 - Automatic calculation of part production costs and part/nest utilization

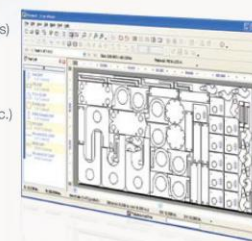

Advantage+

- Better productivity
- Improved part quality
- User friendly
- Fast learning curve
- More efficient use
- Fewer errors

CNC PLASMA CUTTING MACHINE

Your partner for presentation of the needs

**5 Axes
Cutting Technology.**

Offers an advanced solution with more multiple cutting angles. It offers potential savings from additional procedures with cutting of different contours without burr. Flexible operation with aluminium, stainless steel and mild steel.

Automatic angle adjusting technology maximizes your production time.

5 Axes Cutting Head
Operate your special drawings easily and sensitively with 5 axes cutting head which you can do angled cuts.



CNC PLASMA CUTTING MACHINE

Your partner for presentation of the needs

Add another dimension to your cutting capacity.



Cutting head moves up and down with Z axis and right and left with X axis.



Can move totally 180 degrees at A axis.



With totally +140 and 330 degrees moving area at C axis, has a 470 degrees moving and operation area in total.

All angles are calculated automatically with 5 axes cutting technology. During the cutting process, it composes the angle value automatically, which the operator needs to enter. 5 axes cutting technology is a perfect solution for vertical and angular cuts.

Automatic angle adjustment provides time saving to the operator and removes the issues which could be caused by operator errors.

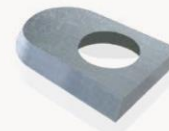

20 mm Mild Steel

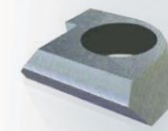

35 mm Mild Steel



50 mm Mild Steel

True Hole™ Technology



Impressive cuts: True Hole™ Technology

True Hole Technology, which has been developed for carbon steel, comes as standard with automatic gas controlled HPRXD® plasma system. Patented True Hole™ technology which was developed for carbon sheet, is a specific combination of cutting parameters which were optimised according to different hole sizes and material thicknesses.

With True Hole™, you acquire more consistent part dimensions and hence you need fewer second operations.

When this technology is compared with other plasma systems in the market, it provides enhancement in quality up to 50% in cylinder holes opened on carbon steel.



Precise holes with True Hole™ Technology...

Without True Hole

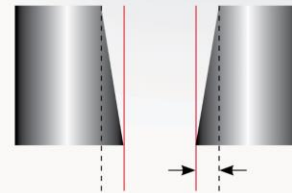

12 mm hole cutting without True Hole Technology

With True Hole



12 mm hole cuts with True Hole Technology

How is True Hole™ Technology obtained?

Achieved with EDGE® Pro Controller, ArcGlide™ THC, HPRXD®, Automatic gas system and ProNest® nesting software and well-matched cutting table.



True Hole™ technology of Hypertherm is a special combination of cutting parameters optimised for every single material thickness and hole dimensions

- Performed gas type
- Gas flow
- Amper
- Drilling method
- Input/output technique
- Cutting speed
- Timing

CNC PLASMA CUTTING MACHINE

Your partner for presentation of the needs

Pipe Cutting Technology.

Ermaksan EPL Plasma series are designed for sensitive cuts on 50 - 400 diameter pipes and perfect cuts at pipes with 32 mm thickness.

These machines have a large utilization area such as; tank manufacturing, pipe line etc.

Also there is an option of making bevel cuts with the 5 axis cutting head.

Infinity control unit
Easy usage, user friendly and efficient.

Hypertherm® 130XD® Plasma source
High efficiency, high performance and excellent cutting technology with 260XD, 400XD, 800XD. (Optional)

Filter unit (Optional)
Vacuums and filters the fume, which occurs while cutting, and provides a healthy working field.

Iht M4000 Pcs
Torch height control.

Chuck system with vacuum feature
Excellent efficiency with the vacuum and filter form through the pipe system.

Manual pipe support system
Manual pipe support system that provides the facility to cut 50 - 400 mm diameter pipes.



CNC PLASMA CUTTING MACHINE

Your partner for presentation of the needs

Impressive solutions at pipe cut...

Advantages+

- Sensitive and qualified cuts with Hypertherm XD® plasma source
- Meeting the high speed plasma cutting standards with impeccable filtration system thanks to inner pipe suction design.
- High precision for edge cuts and round cuts with the milled teeth helical rack and pinion.
- Manual support system that provides 50 – 400 diameter pipe cuts.
- Advanced Height control unit designed for plasma cutting.
- A design that protects mechanical parts from fumes or impacts.
- Infinity CNC control unit is easy to use and efficient
- Software Lantek Cad/Cam
- Marking speciality
- Feature of returning backward and continue to cut where ever needed.
- Large utilization area like tank manufacturing, pipe line etc.



You can do bevel (angled) cuts with the 5 axis cutting head which is optional.

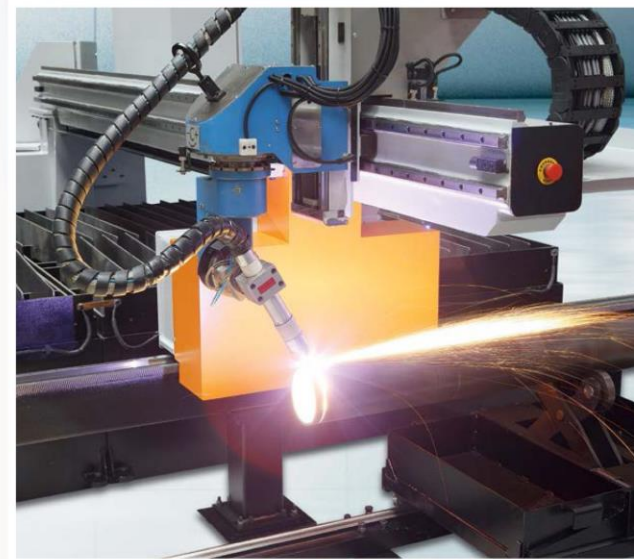

TECHNICAL FEATURES		EPL 1530	EPL 2040	EPL 2060	EPL 20120	EPL 2560	EPL 25120	EPL 3060	EPL 30120	EPL 4060	EPL 40120
CUTTING WIDTH	mm	1500	2000	2000	2000	2500	2500	3000	3000	4000	4000
TOTAL WIDTH	mm	3500	4700	4700	4700	5200	5200	5700	5700	6700	6700
TOTAL HEIGHT	mm	2280	2280	2280	2280	2280	2280	2280	2280	2280	2280
INTER GAP	mm	250	250	250	250	250	250	250	250	250	250
TORCH DISTANCE	mm	0 - 200	0 - 200	0 - 200	0 - 200	0 - 200	0 - 200	0 - 200	0 - 200	0 - 200	0 - 200
CUTTING LENGTH	mm	3000	4000	6000	12000	6000	12000	6000	12000	6000	12000
TABLE HEIGHT	mm	750	750	750	750	750	750	750	750	750	750
SPEED	m/min	35	35	35	35	35	35	35	35	35	35
AXIS	-	X, Y, Z, B	X, Y, Z, B	X, Y, Z, B	X, Y, Z, B	X, Y, Z, B	X, Y, Z, B	X, Y, Z, B	X, Y, Z, B	X, Y, Z, B	X, Y, Z, B
PIPE CUT DIAMETERS MIN. - MAX.	mm	Ø50 - Ø400	Ø50 - Ø400	Ø50 - Ø400	Ø50 - Ø400	Ø50 - Ø400	Ø50 - Ø400	Ø50 - Ø400	Ø50 - Ø400	Ø50 - Ø400	Ø50 - Ø400
MAX THICKNESS (MILD STEEL)	mm	32	32	32	32	32	32	32	32	32	32
POSITIONING ACCURACY	mm	± 0,1 DIN 28206	± 0,1 DIN 28206	± 0,1 DIN 28206	± 0,1 DIN 28206	± 0,1 DIN 28206	± 0,1 DIN 28206	± 0,1 DIN 28206	± 0,1 DIN 28206	± 0,1 DIN 28206	± 0,1 DIN 28206
REPOSITIONING ACCURACY	mm	± 0,05 DIN 28206	± 0,05 DIN 28206	± 0,05 DIN 28206	± 0,05 DIN 28206	± 0,05 DIN 28206	± 0,05 DIN 28206	± 0,05 DIN 28206	± 0,05 DIN 28206	± 0,05 DIN 28206	± 0,05 DIN 28206
PLASMA CUTTING UNIT		Hypertherm 130XD	Hypertherm 130XD	Hypertherm 130XD	Hypertherm 130XD	Hypertherm 130XD	Hypertherm 130XD	Hypertherm 130XD	Hypertherm 130XD	Hypertherm 130XD	Hypertherm 130XD
TORCH HEIGHT CONTROL		Iht M4000 Pcs	Iht M4000 Pcs	Iht M4000 Pcs	Iht M4000 Pcs	Iht M4000 Pcs	Iht M4000 Pcs	Iht M4000 Pcs	Iht M4000 Pcs	Iht M4000 Pcs	Iht M4000 Pcs
CUTTING CAPACITIES	mm	1 - 38	1 - 38	1 - 38	1 - 38	1 - 38	1 - 38	1 - 38	1 - 38	1 - 38	1 - 38
ENERGY		400V, 50Hz, 6 bar air	400V, 50Hz, 6 bar air	400V, 50Hz, 6 bar air	400V, 50Hz, 6 bar air	400V, 50Hz, 6 bar air	400V, 50Hz, 6 bar air	400V, 50Hz, 6 bar air	400V, 50Hz, 6 bar air	400V, 50Hz, 6 bar air	400V, 50Hz, 6 bar air
WEIGHT	kg	4900	6050	8350	14850	9100	16650	9850	17850	11350	20850

CNC PLASMA CUTTING MACHINE

Your partner for presentation of the needs

HEB Profile Cutting Technology.

Ermaksan EPL Plasma series enables to cut between 100mm - 600mm with high precision cutting on the IPN, IPE, IPB, HEA and HEB type of profiles. Optionally, the desired custom sizes and applications can be worked.

These machines have a wide range of usage area like construction industry, machinery and defense industry.



Plasma and oxygen cutting head together
(Oxygen cutting head optional)

Linatrol Infinity Control Panel
19" touch screen controller & operator panel



CNC PLASMA CUTTING MACHINE

Your partner for presentation of the needs

Gas-dust extraction filter

Extremely reliable

In Ermaksan EPL plasma series, filter unit is an option. The heavy particles emerging during the cut should be taken away as much as possible. Filtering unit is designed specially for filtering the gas and particles. With this unit the dirty dust is removed, leaving a safe & clean working environment.



Advantages+

- Clean working ambience
- Integrated burr separator inhibiting sparks and heavy particles to Reach into the filtering unit during cutting.
- 99.9% filtration efficiency according to EN 60335/2/69.
- Synchronized automatic start and stop from CNC cutting frame as command

Oxygen Cutting Technology



Station Characteristics

- With Messer-Tanaka oxygen torch; 10 to 120 mm cutting potentiality (300 mm as optional).
- IHT automation capacitive distance and height control.
- IHT automation collision sensor.
- 220 mm standard stroke.
- 350 mm stroke.
- 500 mm stroke.
- 60 mm circle sensor.
- 35 mm circle sensor (optional).
- 75 mm circle sensor (optional).
- Ermaksan auto ignition system.
- Flame is blocked to return to hose from the edge of torch thanks to Messer rebound safety valves.
- Oxygen cutting gas adjustments are done with free of problems thanks to regulator block of cutting, LPG, low and high annealing gases.
- The annealing duration decreases thanks to high annealing valves and thus cutting period is minimised.
- +/- 45 degree manual angled cutting apparatus for oxygen (optional).



CNC PLASMA CUTTING MACHINE

Your partner for presentation of the needs

Diverse Production Solutions Pipe Cutting EPL Plasma

Impressive Integration : Pipe Cutting EPL Plasma

Ermaksan is continually developing to meet current demands. It can offer practical tailored solutions to suit special requests.

The pipe cutting EPL Plasma Series , is designed for cutting pipes with 12 m length and 600 mm diameter. It enables loading with the Automation System , accurate cutting with advanced technology.

